



SHEAFFER®

Pen & Art Supply Co.



CATALOGUE 2017-18



SHEAFFER.

RESPECT THE PAST. INVENT THE FUTURE

Since 1913 Sheaffer has enabled creative minds to pursue their artistic dreams. Over the 104 years of the brand's history, Sheaffer has always respected its past, while inventing its future in order to stay relevant in our ever-changing world.

With the 2017 relaunch of the Sheaffer Pen & Arts Supply Co., this tradition continues via a new offering of colourful

and stylish new tools for creative minds – like the Sheaffer Ion and the Sheaffer Pop – while honouring beloved classic fine writing instruments – like the Sagaris and Prelude. Each Sheaffer writing instrument easily transitions from school, to office to whatever life brings next.

May the new collection ignite your curiosity...

THE GIFT THAT MATTERS

Style matters and mesmerizes around the world. The effortless flow of an A-line skirt. The impossible sleekness of a Gehry skyscraper. Style beckons. Style entices. Style turns a curious onlooker into a passionate advocate.

What's your Sheaffer style? From time-honored classics of years past as seen here, to elaborate designs with premium finishes, a Sheaffer writing instrument easily transitions from office, to home to whatever life brings next.

The worldly style of a Sheaffer writing instrument is something not easily defined.

This year we invite you to explore your own style with the 2016 Sheaffer Collection. It is forever the Gift That Matters – the ever-evolving style that captivates and captures the personal style and life stories of so many loyal fans around the world.

Collectors and first time buyers choose Sheaffer® pens of incredible variety, in both classic and contemporary styles. Each an expression of design and engineering that flows straight to the heart and head of the onlooker.

WARRANTY

LIMITED 1-YEAR WARRANTY

Sheaffer® 100 | Sheaffer® 200
Sheaffer® 300 | Sheaffer® 500
Sheaffer® Stylus | Sheaffer® Sentinel
Sheaffer® VFM

These Sheaffer® writing instruments are warranted against mechanical failure due to defects in material or workmanship for a period of one year from the date of purchase. Sheaffer will repair or replace, at its option, this writing instrument, free of charge, if it has a mechanical failure due to defect in material or workmanship. This warranty does not cover loss, accidental damage, reasonable wear and tear, misuse, or abuse such as improper use and care. Please return the complete writing instrument with **proof of original purchase** to an authorized Sheaffer Service Center and Sheaffer will repair the writing instrument. If a repair is not possible in a reasonable period of time, Sheaffer will exchange the writing instrument for one of comparable value.

LIMITED 3-YEAR WARRANTY

Sheaffer® Sagaris | Sheaffer® Intensity

These Sheaffer® writing instruments are warranted against mechanical failure due to defects in material or workmanship for a period of three (3) years from the date of purchase from an authorized Sheaffer Retailer. Should such mechanical failure occur, please return the complete writing instrument with **proof of original purchase** to an authorized Sheaffer Service Center and Sheaffer will repair the writing instrument. If a repair is not possible in a reasonable period of time, Sheaffer will exchange the writing instrument for one of comparable value.

LIMITED LIFETIME WARRANTY

Sheaffer® Prelude

These Sheaffer® writing instruments are guaranteed against mechanical failure due to original factory defects in materials and workmanship, for the lifetime of its first owner. Should such failure occur, please return the complete instrument to the nearest authorized Sheaffer Service Retailer with proof of first ownership. It will be repaired or exchanged for one of comparable value, free of charge. This warranty does not cover loss, accidental damage, misuse or abuse. Please return the complete writing instrument with **proof of original purchase** to an authorized Sheaffer Service Center and Sheaffer will repair the writing instrument. If a repair is not possible in a reasonable period of time, Sheaffer will exchange the writing instrument for one of comparable value.

TABLE OF CONTENTS

Warranties	1
Sheaffer® Prelude®	3
Sheaffer® Sagaris®	4
Sheaffer® Intensity®	5
Sheaffer® Quattro®	6
Sheaffer® 300	7
Sheaffer® 100	8
Sheaffer® Switch	9
Sheaffer® Award	10
Sheaffer® Sentinel	11
Sheaffer® VFM	14
Sheaffer® Calligraphy®	16
Ferrari® VFM®	20
Ferrari® Intensity®	22
Sheaffer® Ferrari 100® Series	24
Sheaffer® Ferrari 300® Series	25
Gift Boxes Refills and ink	26





SHEAFFER® PRELUDE®

- Comfortable and balanced cigar-shaped profile
- Traditional styling with modern functionality
- Available in fountain pen, roller ball and ballpoint
- Luxury gift box
- Sheaffer Limited Lifetime Warranty

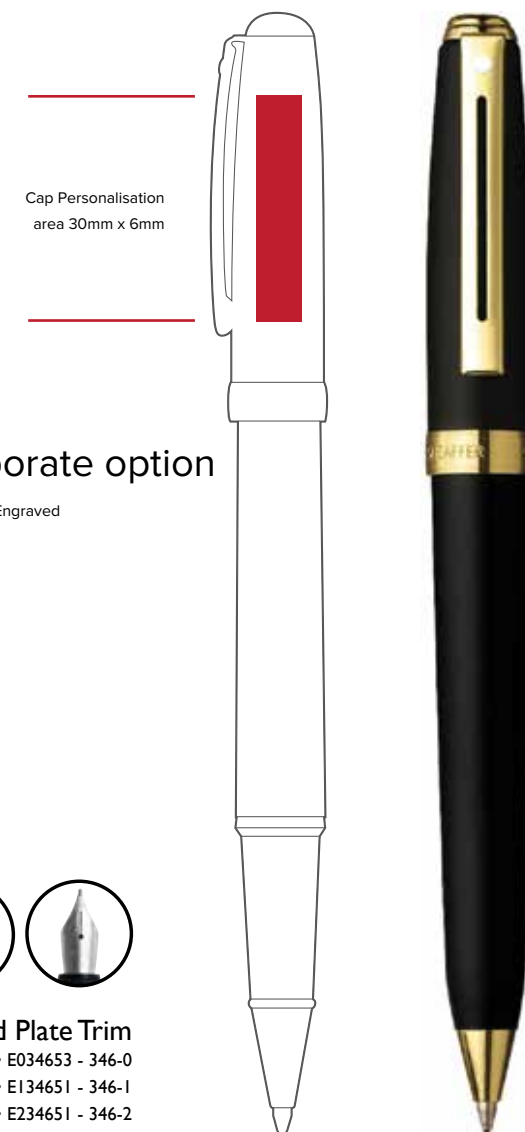

Corporate option

LS Laser Engraved

Black Onyx Barrel Palladium Plate Cap Featuring 22K Gold Plate Trim

Fountain Pen • E034653 - 346-0

Roller Ball • E134651 - 346-1

Ballpen • E234651 - 346-2

SHEAFFER® SAGARIS®

- Classic, timeless style reminiscent of vintage Sheaffer® writing instruments
- Elegant and sophisticated finishes
- Available in fountain pen, roller ball, and ballpoint
- Fountain Pen and Roller Ball feature a tapered cap and barrel and a polished black grip
- Ballpoint is lightweight and slim
- Luxury gift box
- Sheaffer Limited 3 Year Warranty

* Certain modes/finishes may not be available in all markets.

Corporate option

LS Laser Engraved

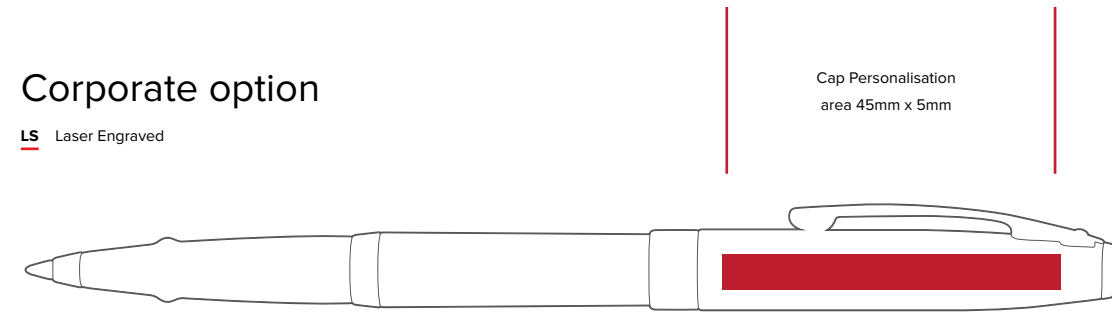

Cap Personalisation
area 45mm x 5mm



Fluted Gold Tone Cap and Barrel Featuring Gold Tone Trim

Roller Ball • E1947451 - 9474-1
Ballpen • E2947451 - 9474-2



Gloss Black Barrel, Bright Chrome Cap Featuring Gold Tone Trim

Fountain Pen • E0947553 - 9475-0
Roller Ball • E1947551 - 9475-1
Ballpen • E2947551 - 9475-2

SHEAFFER® INTENSITY

- Sleek design offered in contemporary finishes
- Appeals to a wide audience
- An easy and impressive gift-giving choice
- Streamlined thin cylinder profile
- Available in fountain pen, roller ball, and ballpoint
- Luxury gift box Sheaffer Limited 3 Year Warranty
- * Certain modes/finishes may not be available in all markets.

Corporate option

LS Laser Engraved

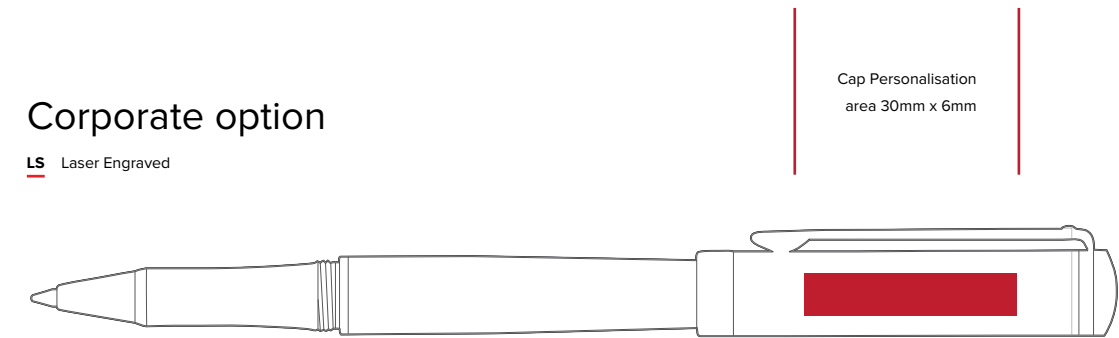

Cap Personalisation
area 30mm x 6mm



Carbon Fibre Featuring Chrome Plate Trim

Fountain Pen • E0923453 - 9234-0
Roller Ball • E1923451 - 9234-1
Ballpen • E2923451 - 9234-2



Onyx Featuring Chrome Plate Trim

Fountain Pen • E0923553 - 9235-0
Roller Ball • E1923551 - 9235-1
Ballpen • E2923551 - 9235-2



Carbon Fibre Barrel, Bright Chrome Cap Featuring Chrome Plate Trim

Fountain Pen • E0923953 - 9239-0
Roller Ball • E1923951 - 9239-1
Ballpen • E2923950 - 9239-2

SHEAFFER® QUATTRO

- Sheaffer's Quattro is a slim and sleek 4-in-1 multifunction pen - their first ever - which offers black, blue and red ballpoints, plus a touch screen stylus as well. Grip section finished in metallic blue with a polished chrome barrel. Sturdy pocket clip featuring the Sheaffer white dot.
- Twist the barrel to select each ink colour. Takes D1 multipen refills. Dimensions: 137mm long, weighs 26g. Supplied in a smart card giftbox.

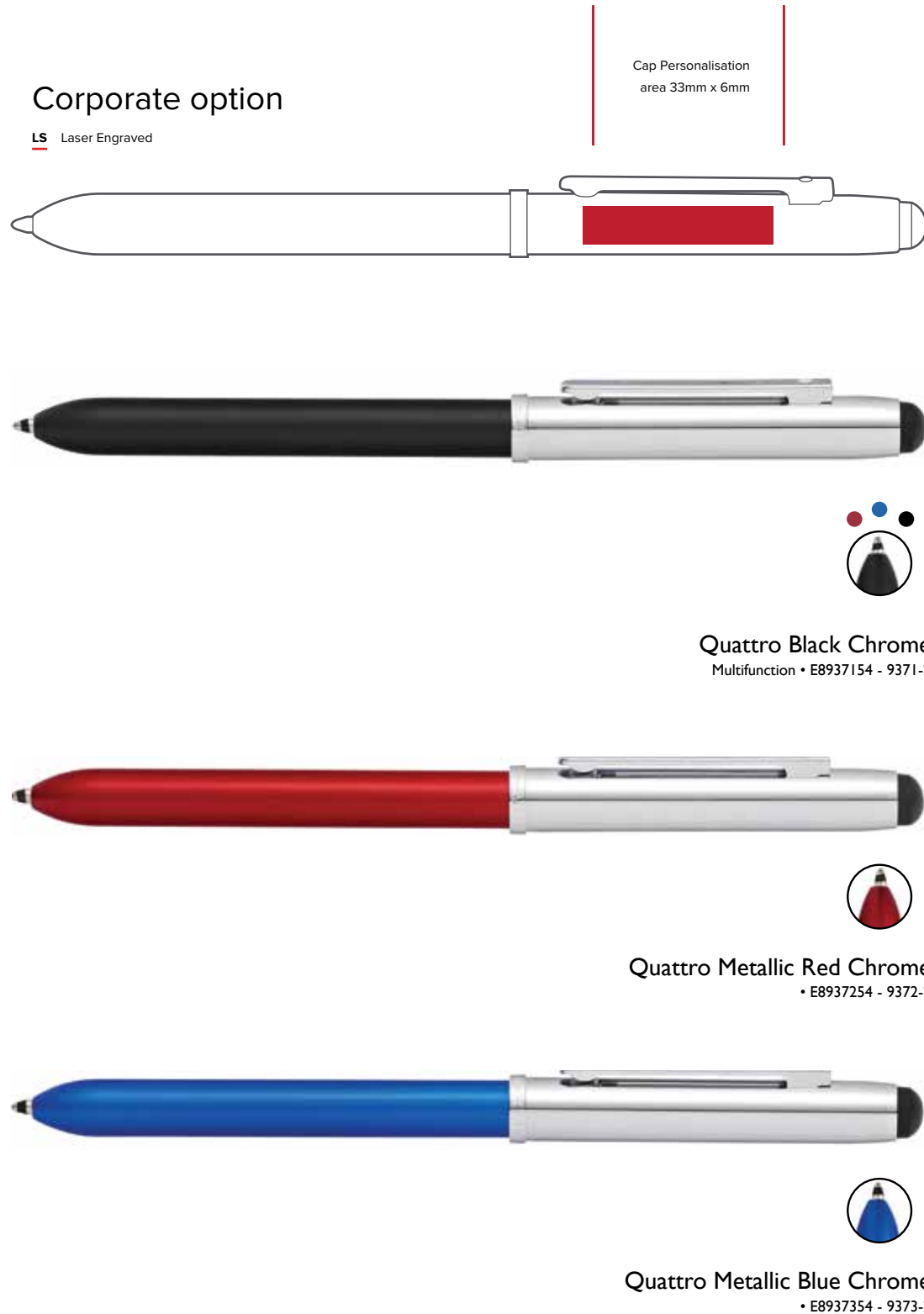

SHEAFFER® 300

- Modern design and elegant finishes personify elegance
- Available in fountain pen, roller ball and ballpoint
- Luxury gift box
- Sheaffer Limited 1 Year Warranty
- * Certain modes/finishes may not be available in all markets.



SHEAFFER® 100

- Available in fountain pen, roller ball, ballpoint
- Fountain Pen available with medium point grade nib
- Luxury gift box
- Sheaffer Limited 1 Year Warranty
- * Certain modes/finishes may not be available in all markets.

Corporate option

LS Laser Engraved

Cap Personalisation
area 30mm x 6mm

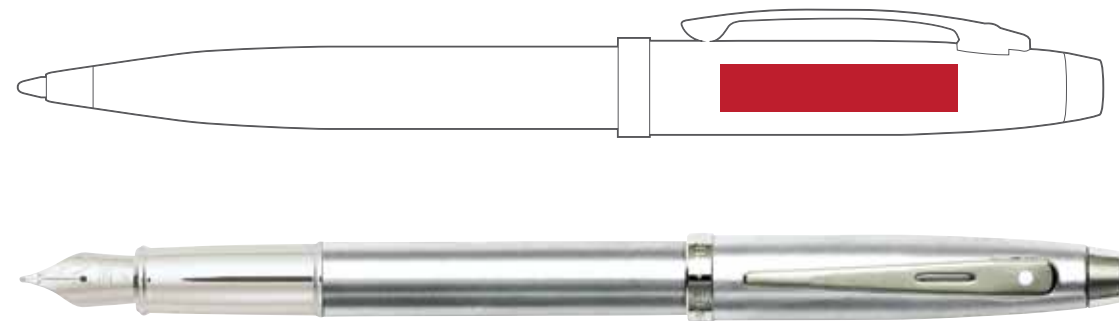

Brushed Chrome Featuring Nickle Plate Trim

Fountain Pen • E0930653-30 - 9306-0
Roller Ball • E1930651-30 - 9306-01
Ballpen • E2930651-30 - 9306-2



Glossy Black Barrel, Brushed Chrome Cap Featuring Nickle Plate Trim

Fountain Pen • E0931351-30 - 9313-0
Roller Ball • E1931351-30 - 9313-1
Ballpen • E2931351-30 - 9313-2



White Lacquer, Brushed Chrome Trim

Fountain Pen • E0932453-30 - 9324-0
Roller Ball • E0932451-30 - 9324-1
Ballpen • E0932451-30 - 9324-2

SHEAFFER® SWITCH

- Popular Ballpoint pen technology with attached Stylus for use on touch-screen devices
- Available in four classic, metallic finishes with chrome appointments
- Features a smooth twist action mechanism that securely locks in position during use
- * Certain modes/finishes may not be available in all markets.

Corporate option

LS Laser Engraved

Cap Personalisation
area 34mm x 5mm



SWITCH METALLIC BLACK

Ballpen • E2915751 - 9157-2



SWITCH METALLIC BLUE

Ballpen • E2915851 - 9158-2



SWITCH METALLIC RED

Ballpen • E2916051 - 9160-2



SWITCH SATIN CHROME

Ballpen • E2915951 - 9159-2

SHEAFFER® AWARD

- Contemporary finishes, with chrome plated trim, the new Sheaffer Award Collection is not only a great pen but at a great price. The New Award collection in contemporary finishes, with chrome plated trim, offers the perfect gift at a fantastic price.
- The highlight of the pen is the chunky profile and rubberized grip, designed for long hours of writing, and the smooth operating twist mechanism.
- * *Certain modes/finishes may not be available in all markets.*

Corporate option

LS Laser Engraved

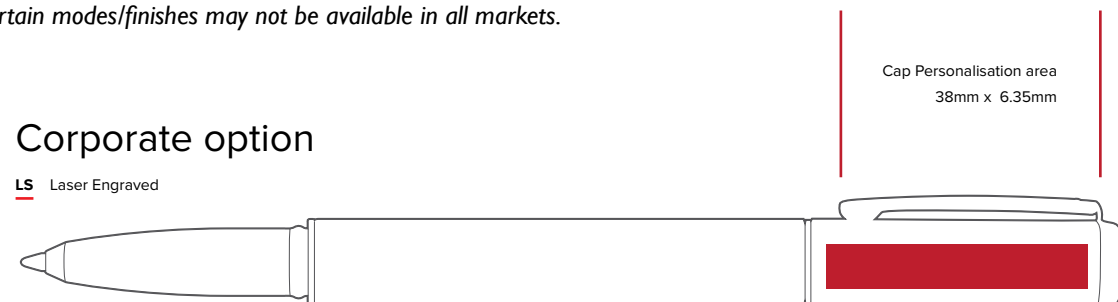

Award Brushed Chrome

Ballpen • E2919051 - 9190-2
 Roller Ball • E1919051 - 9190-1
 Fountain Pen • E0919053 - 9190-0



Award Matt Red

Ballpen • E2919151 - 9191-2
 Roller Ball • E1919151 - 9191-1
 Fountain Pen • E0919153 - 9191-0



Award Matt Black

Ballpen • E2919251 - 9192-2
 Roller Ball • E1919251 - 9192-1
 Fountain Pen • E0919253 - 9192-0

SHEAFFER® SENTINEL

- Slim profile, classic styling
- Convenient push button mechanism
- Reliable precision writing instrument
- Excellent gift for a student or professional
- Available in ballpoint and pencil
- Standard gift box
- Sheaffer Limited 1 Year Warranty
- Certain modes/finishes may not be available in all markets.*
- * *Pencil not available*

Corporate option

LS Laser Engraved

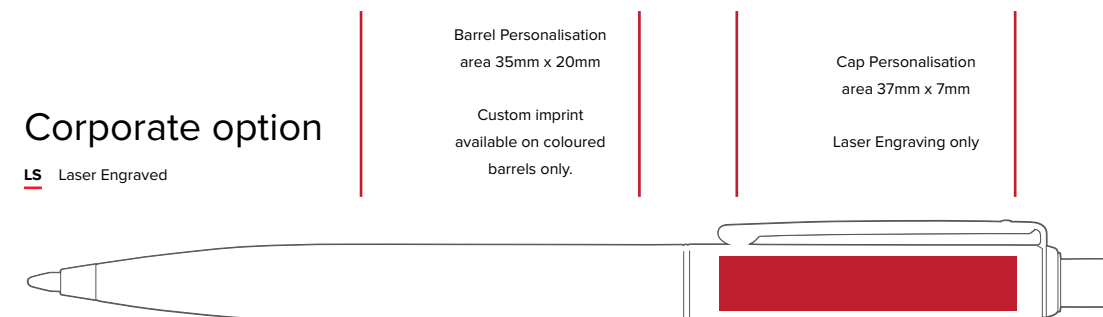

Pink Barrel, Brushed Chrome Cap Featuring Nickel Plate Trim

Ballpen • E23216551 - 321-2



Purple Barrel, Brushed Chrome Cap Featuring Nickel Plate Trim

Ballpen • E23211451 - 321-2



Turquoise Barrel, Brushed Chrome Cap Featuring Nickel Plate Trim

Ballpen • E23211951 - 321-2



Ultramarine Barrel, Brushed Chrome Cap Featuring Nickel Plate Trim

Ballpen • E23214451 - 321-2

SHEAFFER® SENTINEL



Green Barrel, Brushed Chrome Cap Featuring Nickel Trim
Ballpen • E23215151 - 321-2
SET • E93215150 - 321-9



Burgundy Barrel, Brushed Chrome Cap Featuring Nickel Plate Trim
Ballpen • E23217251 - 321-2
SET • E93217251 - 321-9



Blue Barrel, Brushed Chrome Cap Featuring Nickel Plate Trim
Ballpen • E23217351 - 321-2
SET • E93217351 - 321-9



SHEAFFER® SENTINEL



Matte Black Featuring Gold Tone Trim
Ballpen • E232751 - 327-2



Brushed Chrome Plate Featuring Gold Tone Trim
Ballpen • E232551 - 325-2
SET • E932551 - 325-9



Black Barrel, Brushed Chrome Cap Featuring Nickel Plate Trim
Ballpen • E23211151 - 321-2
SET • E93211151 - 321-9



Brushed Chrome Plate Featuring Nickel Plate Trim
Ballpen • E232351 - 323-2
SET • E932351 - 323-9



SHEAFFER® VFM

- Vibrant, fun, modern
 - The perfect gift for students or entry level professionals
 - Contemporary finishes and modern look appeal to wide audience
 - Available in fountain pen, roller ball and ballpoint
 - Fountain Pen available with medium point grade nib
 - Standard gift box
 - Sheaffer Limited 1 Year Warranty
- Certain modes/finishes may not be available in all markets.
- * Fountain pen and roller ball not available

Corporate option

LS Laser Engraved

Barrel Personalisation
area 25mm x 20mm

Custom imprint
available on
coloured barrels only.

Cap
Personalisation
area 30mm x 6mm



Strobe Silver Featuring Nickle Plate Trim

Fountain Pen • E0940053 - 9400-0
Roller Ball • E1940051 - 9400-1
Ballpen • E2940051 - 9400-2
SET • E594005351 - 9400-9 - ST SILVER NT



Neon Blue Featuring Nickle Plate Trim

Fountain Pen • E0940153 - 9401-0
Roller Ball • E1940151 - 9401-1
Ballpen • E2940151 - 9401-2
SET • E594015351 - 9401-9 - NEON BLUE NT



SHEAFFER® VFM

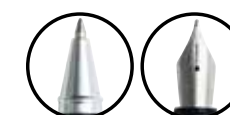

Excessive Red Featuring Nickle Plate Trim

Fountain Pen • E0940353 - 9403-0
Roller Ball • E1940351 - 9403-1
Ballpen • E2940351 - 9403-2
SET • E594035350 - 9403-9 - EXC RED NT



Matt Black Featuring Nickle Plate Trim

Fountain Pen • E0940553 - 9405-0
Roller Ball • E1940551 - 9405-1
Ballpen • E2940551 - 9405-2
SET • E594055351 - 9405-9 - MAT BLK NT



Pink Sapphire
Ballpen • E2941651 - 9416-2



the future belongs to the curious

the sheaffer calligraphy collection

#curiousminds



CALLIGRAPHY®

THE ART OF FINE LETTERING



Sheaffer Calligraphy Pink
Fountain Pen • 83400
Fine Nib



Sheaffer Calligraphy Turquoise
Fountain Pen • 83401
Medium Nib



Sheaffer Calligraphy Lime Green
Fountain Pen • 83402
Broad Nib



Calligraphy Mini kit
Fountain Pen • 83403



Calligraphy Large Maxi kit
Fountain Pen • 83404



- Calligraphy Viewpoint® pens feature visible ink supply, comfort grip, and color-coded nibs
- Calligraphy Mini Kit – one pen with three interchangeable nib grades
- Calligraphy Maxi Kit – three pens with three nib grades, an assortment of ink cartridges, tracing pad
- Calligraphy Gift Set – Contents include three Viewpoint® pens, three nib grades (fine, medium and broad), 14 assorted Skrip® ink cartridges and step-by-step Instructions, packaged in a beautiful red gift box.
- All kits include easy step-by- step instructions Sheaffer Limited 1 Year Warranty



Viewpoint Pen - Fine (0.8mm)
Fountain Pen • 73400-D



Viewpoint Pen - Medium (1.3mm)
Fountain Pen • 73401-D



Viewpoint Pen - Broad (1.8mm)
Fountain Pen • 73402-D



Viewpoint
73400 - 73401 - 73402



Calligraphy Mini Kit
SET • 73403-D



Calligraphy Maxi Kit
SET • 73404-D



Ferrari

OFFICIAL LICENSED PRODUCT

Sheaffer® together with Scuderia Ferrari is proud to present Scuderia Ferrari Collection by Sheaffer Writing Instruments. Consisting of five contemporary collections, these premium writing instruments embody values and characteristics synonymous with that of Scuderia Ferrari. Each instrument reflects the same profound passions, extraordinary talent and incredible expertise that drives the Scuderia Ferrari Racing Team.



Rosso Corsa Featuring Nickel Plate Trim
Ballpen • FE2950051 - 9500-2



Glossy Black Featuring Nickel Plate Trim
Ballpen • FE2950551 - 9505-2



Glossy Yellow Featuring Nickel Plate Trim
Ballpen • FE2951051 - 9510-2



Glossy White Featuring Nickel Plate Trim
Ballpen • FE2951151 - 9511-2

- Available as Fountain Pen, Roller Ball or Ballpoint
- Luxury gift box
- Sheaffer Limited 1 Year Warranty
- Certain modes/finishes may not be available in all markets.



Satin Rosso Corsa
 Ballpen • FE29522051 - 9520-2
 Fountain Pen • FE0952053 - 9520-0



Satin Black
 Ballpen • FE29522151 - 9521-2
 Fountain Pen • FE0952153 - 9521-0



Intensity Satin Yellow
 Ballpen • FE2952251 - 9522-2
 Fountain Pen • FE0952253 - 9522-0

Ferrari
 OFFICIAL LICENSED PRODUCT

SHEAFFER® FERRARI 100® SERIES



Rosso Corsa Featuring Nickel Plate Trim

Fountain Pen • FE0950153 - 9501-0
Roller Ball • FE1950151 - 9501-1
Ballpen • FE2950151 - 9501-2



Tire Tread Engraved Featuring Nickel Plate Trim

Fountain Pen • FE0950653 - 9506-0
Roller Ball • FE1950651 - 9506-1
Ballpen • FE2950651 - 9506-2

SHEAFFER® FERRARI 300® SERIES

Each collection is created with the highest level of quality, proudly displaying the Scuderia Ferrari Shield and the world-renowned Sheaffer "White Dot®" symbol of excellence. A variety of technologies are available and all fountain pens carry a stainless steel Sheaffer® nib. For continued writing enjoyment all modes take Sheaffer® refills. Scuderia Ferrari Collection by Sheaffer writing instruments are sure to perform at maximum speeds and delight Ferrari enthusiasts everywhere.

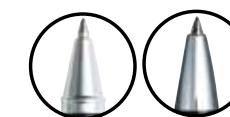

Rosso Corsa Featuring Chrome Plate Trim

Fountain Pen • FE0950353 - 9503-0
Roller Ball • FE1950351 - 9503-1
Ballpen • FE2950351 - 9503-2



Checked Flag Engraving with Gloss Black Finish Featuring Chrome Plate Trim

Fountain Pen • FE0951853 - 9518-0
Roller Ball • FE1951851 - 9518-1
Ballpen • FE2951851 - 9518-2

GIFT BOXES

REFILLS



Standard gift box / Estuche estándar para regalo / Ecrin standard / Standard-Geschenkbox

Luxury gift box / Estuche de lujo para regalo / Ecrin Luxe / Luxus-Geschenkbox

Standard gift box for Sheaffer® VFM, Sentinel®, Pop, Ion and Award

Luxury gift box for Prelude®, Sheaffer® Intensity®, Sheaffer® 100, Sheaffer® 300, Quattro and Switch

REFILLS AND INKS

REFILLS & INKS		
SKRIP 2oz BOTTLED INK (6 Pack) SHELF PACK		
94221	94221 BOTTLED INK BLUE	074040942217
94231	94231 BOTTLED INK BLACK	074040942316
94261	94261 BOTTLED INK BROWN	074040942613
94241	94241 BOTTLED INK RED	074040942415
CLASSIC CARTRIDGES OUTER (1 doz 6 packs) BLISTERCARDED		
96320	96320 CLASS INK CART BLUE (5)	074040963205
96330	96330 CLASS INK CART BLK (5)	074040963304
VFM CARTRIDGES		
93091	93091 UN INK CART BLU (6) VFM	074040930917
93090	93090 UNI INK CART BLK (6) VFM	074040930900
CONVERTORS		
86700	86700 CONVERTER	074040867008
ROLLINGBALL REFILL DOZEN BLISTERCARDS		
97525	97525 SLIM ROLLERBALL BLUE	074040975253
97535	97535 SLIM ROLLERBALL BLACK	074040975352
97325	97325 CL ROLLERBALL BLUE	074040973259
97335	97335 CL ROLLERBALL BLACK	074040973358
K BALLPEN REFILLS (Dozens) BLISTER CARDED		
99325	99325 K BALLPEN BLUE MED	074040993257
99335	99335 K BALLPEN BLACK MED	074040993356
99324	99324 K BALLPEN BLUE FINE	074040993240
99334	99334 K BALLPEN BLACK FINE	074040993349
T BALLPEN REFILLS (Dozens) BLISTER CARDED		
99327	99327-2 T BALLPEN BLUE MED	074040993271
99337	99337-2 T BALLPEN BLACK MED	074040993370
ERASERS		
86135	86135 P ERASERS PRELUDE	074040861358
86005	86005 D ERASERS SENTINEL	074040860054

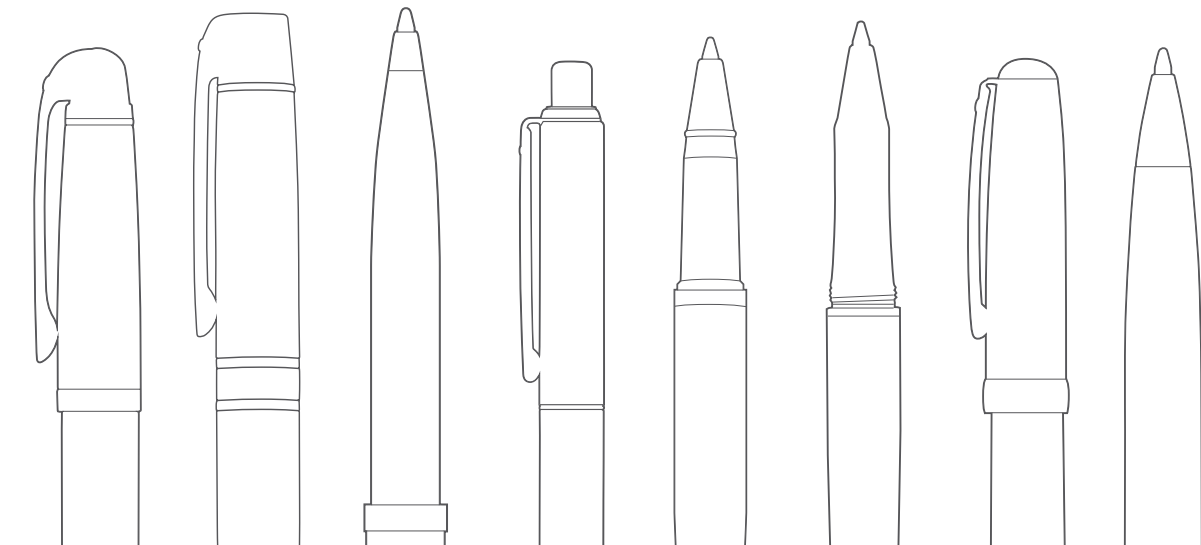

	COLLECTION	BALLPOINT	REF #	ROLLERBALL	REF #	FOUNTAIN PEN	REF #
	PRELUDE	"K" BLACK MEDIUM	99335	CLASSIC BLACK	97335	CLASSIC CARTRIDGE BLACK	96330
		"K" BLACK FINE	99334	CLASSIC BLUE	97325	CLASSIC CARTRIDGE BLUE	96320
		"K" BLUE MEDIUM	99325				
		"K" BLUE FINE	99324				
	SAGARIS	"T" BLACK MEDIUM	99337	SLIM BLACK	97535	CLASSIC CARTRIDGE BLACK	96330
		"T" BLUE MEDIUM	99327	SLIM BLUE	97525	CLASSIC CARTRIDGE BLUE	96320
	INTENSITY	"K" BLACK MEDIUM	99335	SLIM BLACK	97535	CLASSIC CARTRIDGE BLACK	96330
		"K" BLACK FINE	99334	SLIM BLUE	97525	CLASSIC CARTRIDGE BLUE	96320
		"K" BLUE MEDIUM	99325				
		"K" BLUE FINE	99324				
	SERIES 300	"K" BLACK MEDIUM	99335	SLIM BLACK	97535	CLASSIC CARTRIDGE BLACK	96330
		"K" BLACK FINE	99334	SLIM BLUE	97525	CLASSIC CARTRIDGE BLUE	96320
		"K" BLUE MEDIUM	99325				
		"K" BLUE FINE	99324				
	SERIES 100	"K" BLACK MEDIUM	99335	SLIM BLACK	97535	CLASSIC CARTRIDGE BLACK	96330
		"K" BLACK FINE	99334	SLIM BLUE	97525	CLASSIC CARTRIDGE BLUE	96320
		"K" BLUE MEDIUM	99325				
		"K" BLUE FINE	99324				
	QUATTRO (Uses Cross Refills)	MINI BLACK	8518-4				
		MINI RED	8518-5				
		MINI BLUE	8518-6				
	SWITCH	"K" BLACK MEDIUM	99335				
		"K" BLACK FINE	99334				
		"K" BLUE MEDIUM	99325				
		"K" BLUE FINE	99324				
	AWARD (Uses Cross Refills)	BLACK FINE	8514	STANDARD GEL BLACK	8523	STANDARD CARTRIDGE BLACK	8921
		BLACK MEDIUM	8513	STANDARD GEL BLUE	8521	STANDARD CARTRIDGE BLUE	8920
		BLACK BROAD	8101				
		BLUE FINE	8512				
		BLUE MEDIUM	8511				
		BLUE BROAD	8510				
	SENTINEL	"K" BLACK MEDIUM	99335				
		"K" BLACK FINE	99334				
		"K" BLUE MEDIUM	99325				
		"K" BLUE FINE	99324				
	VFM	"K" BLACK MEDIUM	99335	SLIM BLACK	97535	UNIVERSAL CARTRIDGE BLACK	93090
		"K" BLACK FINE	99334	SLIM BLUE	97525	UNIVERSAL CARTRIDGE BLUE	93091
		"K" BLUE MEDIUM	99325				
		"K" BLUE FINE	99324				



LUXCO

IMPORTERS (PTY) LTD

Ground Floor, Block G, Pinmill Farm
164 Katherine Street, Sandown
PO Box 650052, Benmore 2010

Telephone: 011 - 448 2210
Main Fax: 011 - 448 2218
Internal Sales and After Sales
Fax: 011 - 448 2217
Website: www.luxco.co.za

DIRECTORS

Managing Director | Russell Hopkins
Cell: 082 808 5715 | E-mail: rh@luxco.co.za

Financial Director | Jakov Shishler
Cell: 082 808 6166 | E-mail: js@luxco.co.za

SALES

Brand Manager | Niki Rowlands
Cell: 072 270 7614 | E-mail: nr@luxco.co.za

Sales Executives | Joshua Hodgskin
Cell: 083 639 7024 | E-mail: jh@luxco.co.za

INTERNAL

Naz Thazool | nt@luxco.co.za

AFTER SALES

Nicola Ferreira | nf@luxco.co.za
Zaida Choonara | zc@luxco.co.za

ACCOUNTS

Motti Shishler | ms@luxco.co.za